



Micro Commercial Components



Micro Commercial Components
20736 Marilla Street Chatsworth
CA 91311
Phone: (818) 701-4933
Fax: (818) 701-4939

GBPC25005 THRU GBPC2510

Features

- Halogen free available upon request by adding suffix "-HF"
- Glass Passivated Chip Junction
- Surge Rating Of 300 Amps
- Mounting Hole For #10 Screw
- Any Mounting Position
- With heat sink on top
- Epoxy meets UL 94 V-0 flammability rating
- Moisture Sensitivity Level 1
- Lead Free Finish/RoHS Compliant(Note 1)("P" Suffix designates RoHS Compliant. See ordering information)

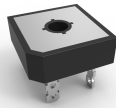

25 Amp Glass Passivated Single Phase Bridge Rectifier 50 to 1000 Volts

Maximum Ratings

- Operating Temperature: -55°C to +150°C
- Storage Temperature: -55°C to +150°C
- UL Recognized File # E165989
- Mounting Torque: 8.0 in-lbs Maximum

MCC Catalog Number	Device Marking	Maximum Recurrent Peak Reverse Voltage	Maximum RMS Voltage	Maximum DC Blocking Voltage
GBPC25005	GBPC25005	50V	35V	50V
GBPC2501	GBPC2501	100V	70V	100V
GBPC2502	GBPC2502	200V	140V	200V
GBPC2504	GBPC2504	400V	280V	400V
GBPC2506	GBPC2506	600V	420V	600V
GBPC2508	GBPC2508	800V	560V	800V
GBPC2510	GBPC2510	1000V	700V	1000V

GBPC

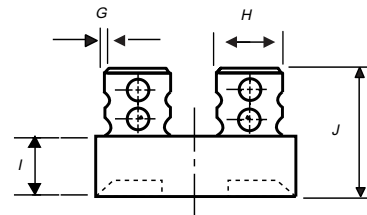
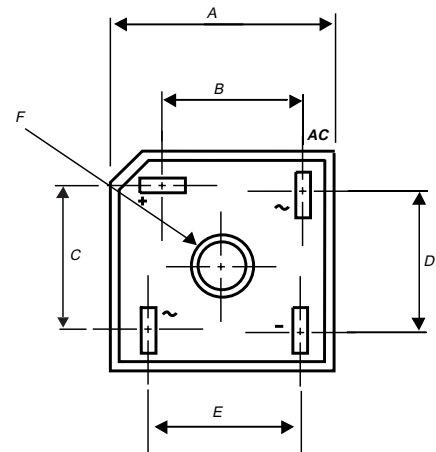

Electrical Characteristics @ 25°C Unless Otherwise Specified

Average Forward Current	$I_{F(AV)}$	25.0A	$T_C = 60^\circ\text{C}$
Peak Forward Surge Current	I_{FSM}	300A	8.3ms, half sine
Maximum Forward Voltage Drop Per Element	V_F	1.1V	$I_{FM} = 12.5\text{A per element}; T_J = 25^\circ\text{C}$
Maximum DC Reverse Current At Rated DC Blocking Voltage	I_R	5 μA 500 μA	$T_J = 25^\circ\text{C}$ $T_J = 125^\circ\text{C}$

Notes: 1.High Temperature Solder Exemption Applied,see EU Directive Annex Notes 7.

DIMENSIONS

DIM	INCHES		MM		NOTE
	MIN	MAX	MIN	MAX	
A	1.114	1.134	28.30	28.80	
B	.634	.673	16.10	17.10	
C	.634	.673	16.10	17.10	
D	.543	.583	13.80	14.80	
E	.693	.732	17.60	18.60	
F	0.197 Nominal		5.00 Nominal		∅
G	.030	.034	0.76	0.86	
H	.244	.256	6.20	6.50	
I	.291	.315	7.40	8.00	
J	.740	.839	18.80	21.30	

www.mccsemi.com

GBPC25005 thru GBPC2510

Figure 1
Typical Forward Characteristics

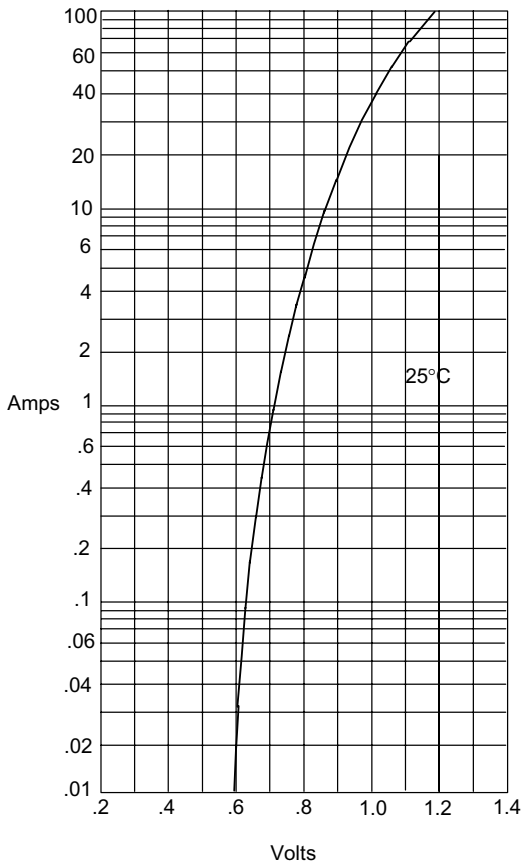

Instantaneous Forward Current - Amperes versus Instantaneous Forward Voltage - Volts

Figure 2
Typical Reverse Characteristics

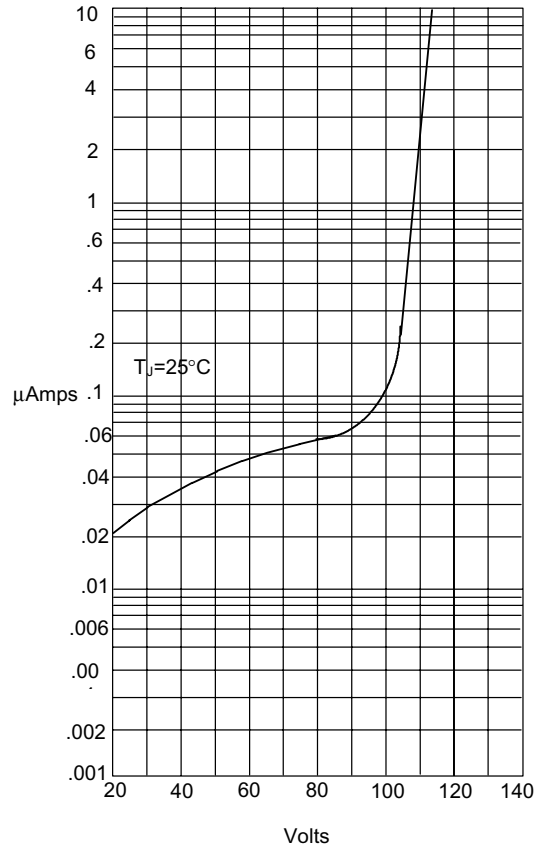

Instantaneous Reverse Leakage Current - MicroAmperes versus Percent Of Rated Peak Reverse Voltage - Volts

Figure 3
Forward Derating Curve

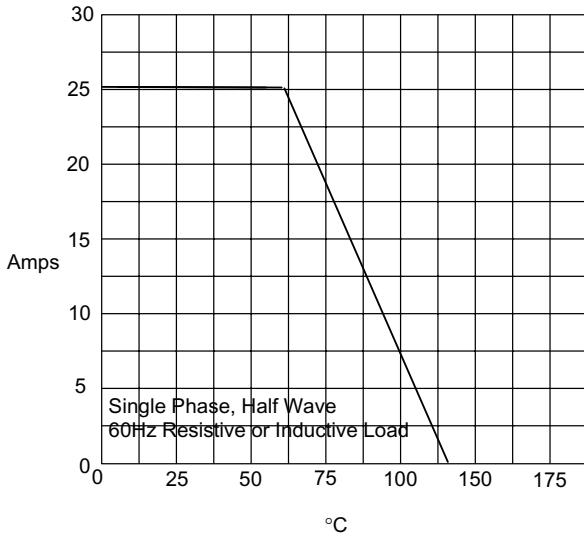

Average Forward Rectified Current - Amperes versus Case Temperature - °C

Figure 4
Peak Forward Surge Current

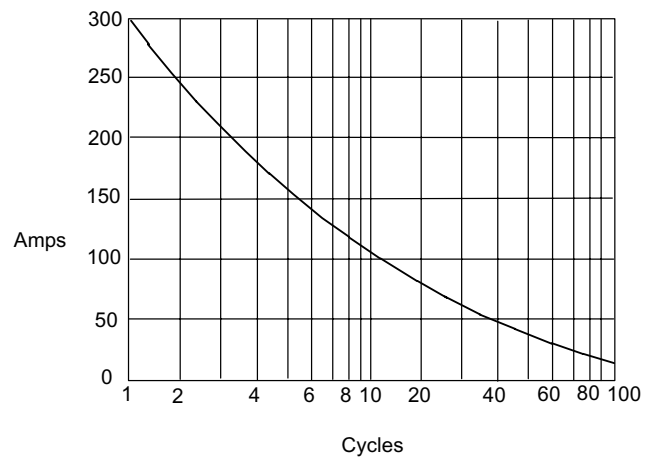

Peak Forward Surge Current - Amperes versus Number Of Cycles At 60Hz - Cycles



Micro Commercial Components

Ordering Information

Device	Packing
(Part Number)-BP	Bulk;400Pcs/Ctn

Note : Adding "-HF" suffix for halogen free, eg. Part Number-BP-HF

IMPORTANT NOTICE

Micro Commercial Components Corp. reserves the right to make changes without further notice to any product herein to make corrections, modifications, enhancements, improvements, or other changes. **Micro Commercial Components Corp.** does not assume any liability arising out of the application or use of any product described herein; neither does it convey any license under its patent rights, nor the rights of others. The user of products in such applications shall assume all risks of such use and will agree to hold **Micro Commercial Components Corp.** and all the companies whose products are represented on our website, harmless against all damages.

LIFE SUPPORT

MCC's products are not authorized for use as critical components in life support devices or systems without the express written approval of Micro Commercial Components Corporation.

CUSTOMER AWARENESS

Counterfeiting of semiconductor parts is a growing problem in the industry. Micro Commercial Components (MCC) is taking strong measures to protect ourselves and our customers from the proliferation of counterfeit parts. MCC strongly encourages customers to purchase MCC parts either directly from MCC or from Authorized MCC Distributors who are listed by country on our web page cited below. Products customers buy either from MCC directly or from Authorized MCC Distributors are genuine parts, have full traceability, meet MCC's quality standards for handling and storage. **MCC will not provide any warranty coverage or other assistance for parts bought from Unauthorized Sources.** MCC is committed to combat this global problem and encourage our customers to do their part in stopping this practice by buying direct or from authorized distributors.

www.mccsemi.com