

PRELIMINARY
 Notice: This is not a final specification.
 Some parametric limits are subject to change.

MITSUBISHI Pch POWER MOSFET

FX20ASJ-2

HIGH-SPEED SWITCHING USE

FX20ASJ-2



- 4V DRIVE
- V_{DSS} -100V
- $r_{DS(ON)}$ (MAX) 0.26Ω
- I_D -20A
- Integrated Fast Recovery Diode (TYP.) 100ns

OUTLINE DRAWING Dimensions in mm

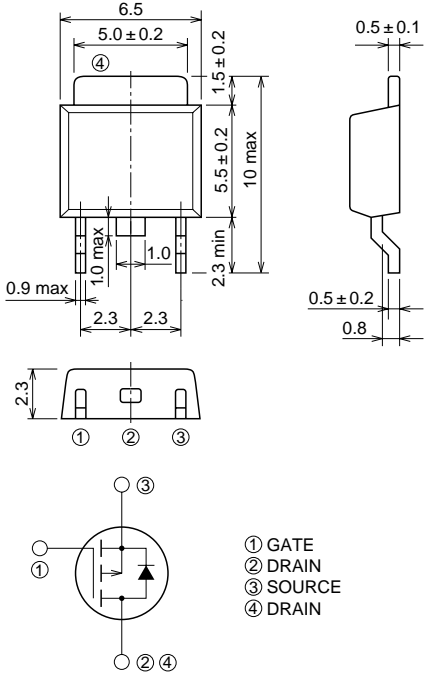

① GATE
 ② DRAIN
 ③ SOURCE
 ④ DRAIN

MP-3

APPLICATION

Motor control, Lamp control, Solenoid control
 DC-DC converter, etc.

MAXIMUM RATINGS (Tc = 25°C)

Symbol	Parameter	Conditions	Ratings	Unit
V_{DSS}	Drain-source voltage	$V_{GS} = 0V$	-100	V
V_{GSS}	Gate-source voltage	$V_{DS} = 0V$	± 20	V
I_D	Drain current		-20	A
I_{DM}	Drain current (Pulsed)		-80	A
I_{DA}	Avalanche drain current (Pulsed)	$L = 50\mu H$	-20	A
I_S	Source current		-20	A
I_{SM}	Source current (Pulsed)		-80	A
P_D	Maximum power dissipation		35	W
T_{ch}	Channel temperature		-55 ~ +150	°C
T_{stg}	Storage temperature		-55 ~ +150	°C
—	Weight	Typical value	0.26	g

PRELIMINARY
 Notice: This is not a final specification.
 Some parametric limits are subject to change.

ELECTRICAL CHARACTERISTICS (Tch = 25°C)

Symbol	Parameter	Test conditions	Limits			Unit
			Min.	Typ.	Max.	
V (BR) DSS	Drain-source breakdown voltage	ID = -1mA, VGS = 0V	-100	—	—	V
IGSS	Gate-source leakage current	VGS = ±20V, VDS = 0V	—	—	±0.1	μA
IDSS	Drain-source leakage current	VDS = -100V, VGS = 0V	—	—	-0.1	mA
VGS (th)	Gate-source threshold voltage	ID = -1mA, VDS = -10V	-1.0	-1.5	-2.0	V
rDS (ON)	Drain-source on-state resistance	ID = -10A, VGS = -10V	—	0.20	0.26	Ω
rDS (ON)	Drain-source on-state resistance	ID = -10A, VGS = -4V	—	0.25	0.32	Ω
VDS (ON)	Drain-source on-state voltage	ID = -10A, VGS = -10V	—	-2.0	-2.6	V
yfs	Forward transfer admittance	ID = -10A, VDS = -10V	—	10.3	—	S
Ciss	Input capacitance	VDS = -10V, VGS = 0V, f = 1MHz	—	2360	—	pF
Coss	Output capacitance		—	198	—	pF
Crss	Reverse transfer capacitance		—	99	—	pF
td (on)	Turn-on delay time		—	13	—	ns
tr	Rise time	VDD = -50V, ID = -10A, VGS = -10V, RGEN = RGS = 50Ω	—	30	—	ns
td (off)	Turn-off delay time		—	139	—	ns
tf	Fall time		—	74	—	ns
VSD	Source-drain voltage		IS = -10A, VGS = 0V	—	-1.0	-1.5
Rth (ch-c)	Thermal resistance	Channel to case	—	—	3.57	°C/W
trr	Reverse recovery time	IS = -20A, dis/dt = 100A/μs	—	100	—	ns

PERFORMANCE CURVES

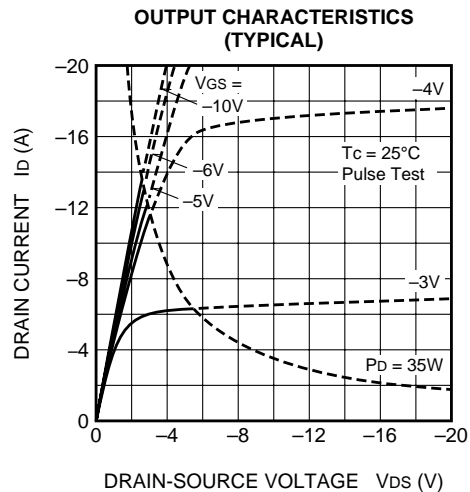
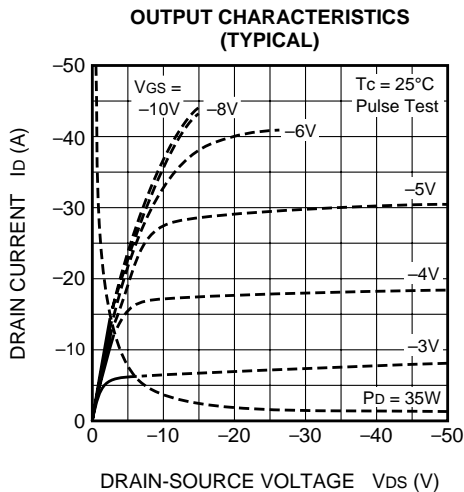
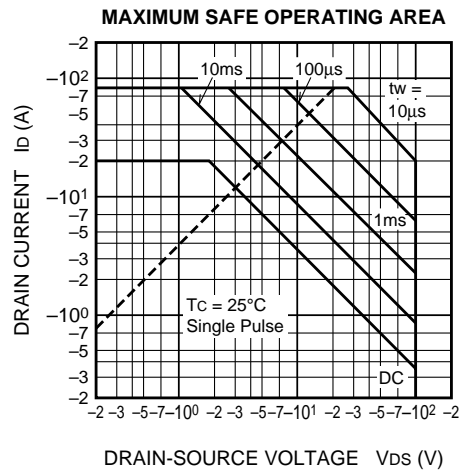
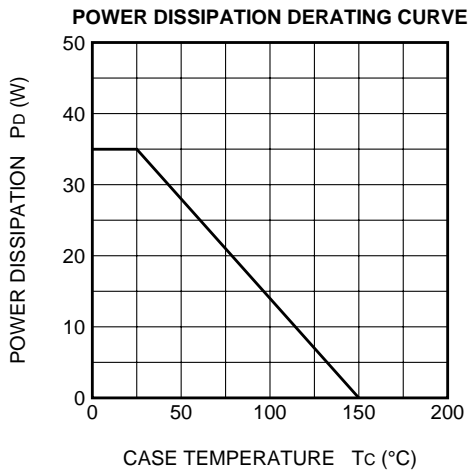

PRELIMINARY
 Notice: This is not a final specification.
 Some parametric limits are subject to change.

ON-STATE VOLTAGE VS. GATE-SOURCE VOLTAGE (TYPICAL)

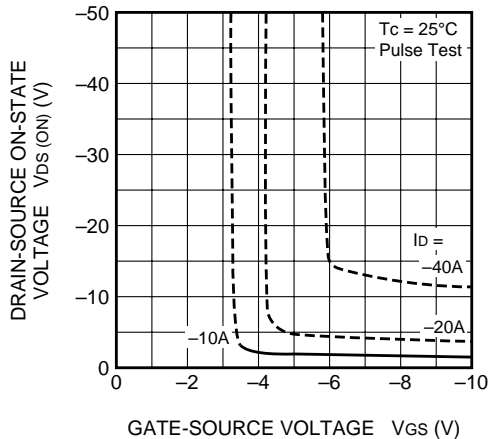

ON-STATE RESISTANCE VS. DRAIN CURRENT (TYPICAL)

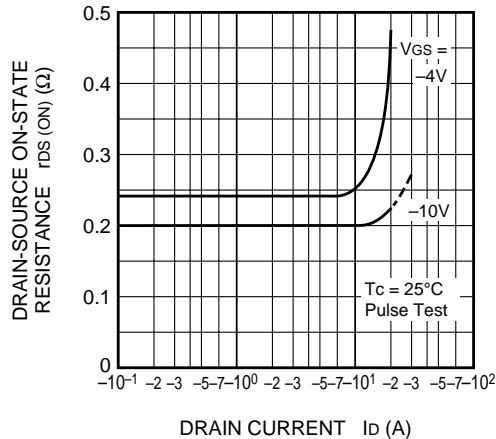

TRANSFER CHARACTERISTICS (TYPICAL)

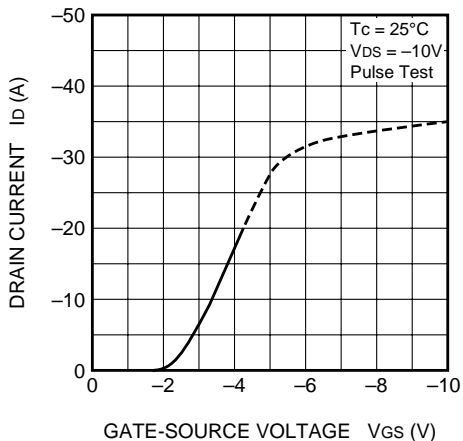

FORWARD TRANSFER ADMITTANCE VS. DRAIN CURRENT (TYPICAL)

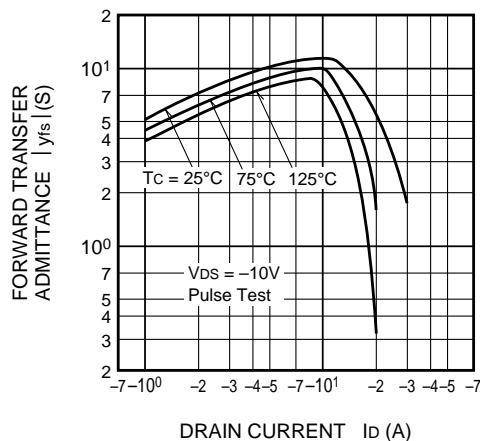

CAPACITANCE VS. DRAIN-SOURCE VOLTAGE (TYPICAL)

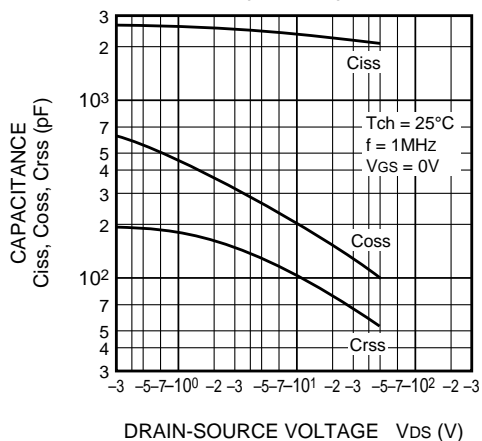

SWITCHING CHARACTERISTICS (TYPICAL)

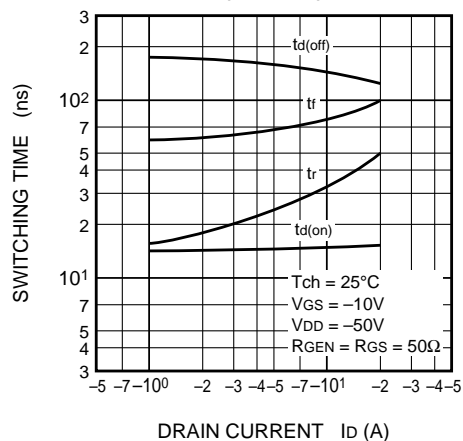

PRELIMINARY
 Notice: This is not a final specification.
 Some parametric limits are subject to change.

GATE-SOURCE VOLTAGE VS. GATE CHARGE (TYPICAL)

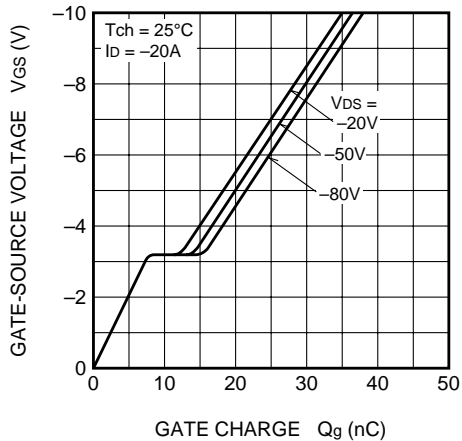

SOURCE-DRAIN DIODE FORWARD CHARACTERISTICS (TYPICAL)

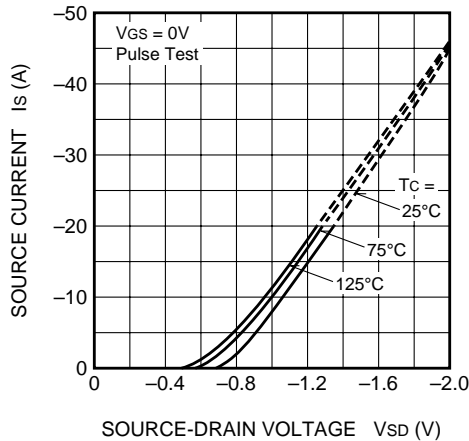

ON-STATE RESISTANCE VS. CHANNEL TEMPERATURE (TYPICAL)

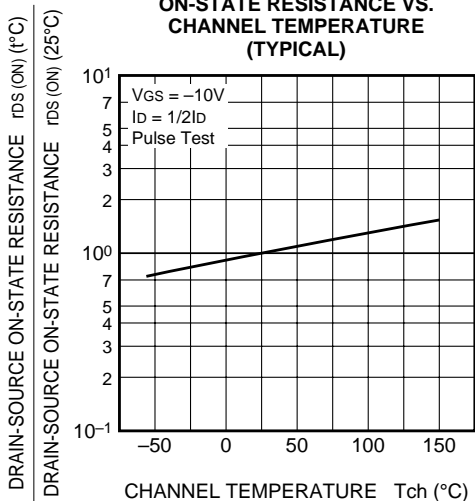

THRESHOLD VOLTAGE VS. CHANNEL TEMPERATURE (TYPICAL)

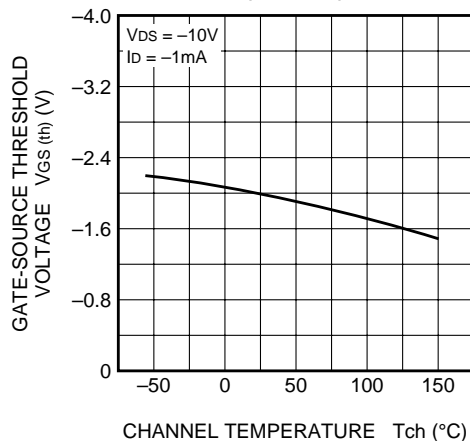

BREAKDOWN VOLTAGE VS. CHANNEL TEMPERATURE (TYPICAL)

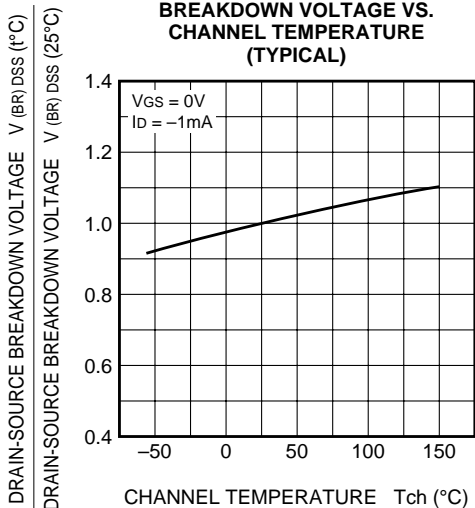

TRANSIENT THERMAL IMPEDANCE CHARACTERISTICS

